

Installation Instructions

RightSight™ PHOTOSWITCH® Photoelectric Sensors

		Polarized Retroreflective	Standard Retroreflective	Diffuse	Sharp Cutoff Diffuse	Background Suppression		Glass Fiber Optic	Transmitted Beam ☉		
						50mm (2in)	100mm (4in)		20m Receiver	4m Receiver	
Optical	Sensing Distance	3m (9.8ft)	4.5m (14.7ft)	500mm (20in)	<127mm (5in)	50mm (2in)	100mm (4in)	Varies w/FO cable	20m (60ft)	4m (13ft)	
	Field of View	7°	2.5°	5°	7°	20°	8°	Varies w/FO cable	7°	7°	
	Transmitting LED	Visible Red 660nm	Visible Red 660nm	Infrared 880nm							
	Sensitivity Adjustment	no	no	yes		no		yes	no		
Mechanical	Housing/Lens Material	Specially formulated polymer/Acrylic									
	Connection Type	(-A2) 2m PVC, 300V cable, (-F4) 4-pin DC micro QD on six inch pigtail, (-G4) 4-pin AC micro QD on six inch pigtail									
	LED Indicators	See table below									
	Supplied Accessories	One 18mm mounting nut, two on fiber optic models									
	Optional Accessories	See accessories for mounting brackets, reflectors, apertures, fiber optic cables, cordsets, and patchcords									
Environmental	Operating Temperature	-25° to +55°C (-13° to +131°F) > 132V AC/DC -25° to +70°C (-13° to +158°F) < 132V AC/DC									
	Operating Environment	NEMA 3R, 4X, 6P, IP67; 8270kPa (1200psi) washdown									
	Vibration/Shock	5g, 10-55Hz, 1mm amplitude, meets or exceeds IEC 947-5-2 / 30G, 1ms pulse duration, meets or exceeds IEC 947-5-2									
	Relative Humidity	95%									
	Approvals	UL, CSA, CE for all applicable directives									
DC Sensors	Catalog Number Complementary LO & DO NPN	42EF-P2MNB-a	—	42EF-D1MNAK-a	42EF-S1MNA-a	42EF-B1MNBC-a	42EF-B1MNBE-a	42EF-G1MNA-a	42EF-R9MNB-a	42EF-R9MNBV-a	
	Complementary LO & DO PNP	42EF-P2MPB-a	—	42EF-D1MPAK-a	42EF-S1MPA-a	42EF-B1MPBC-a	42EF-B1MPBE-a	42EF-G1MPA-a	42EF-R9MPB-a	42EF-R9MPBV-a	
	DO NPN & PNP	42EF-P2KBB-a	42EF-U2KBB-a	42EF-D1KBAK-a	42EF-S1KBA-a	42EF-B1KBBC-a	42EF-B1KBBE-a	42EF-G1KBA-a	42EF-R9KBB-a	42EF-R9KBBV-a	
	LO NPN & PNP	42EF-P2JBB-a	42EF-U2JBB-a	42EF-D1JBAK-a	42EF-S1JBA-a	42EF-B1JBBC-a	42EF-B1JBBE-a	42EF-G1JBA-a	42EF-R9JBB-a	42EF-R9JBBV-a	
DC Sensors	Voltage/Current/Power Consumption	10.8 to 30VDC @ 35mA maximum (1W maximum)									
	Sensor Protection	Input reverse polarity, over voltage, false pulse protected, output short-circuit (SCP) to 100mA, overload									
	Output Type	NPN, PNP, Dual NPN and PNP									
	Output Rating	30V DC @ 100mA maximum (SCP protected)									
	Output Leakage Current	0.1mA maximum									
	Response Time	1ms typical, 4ms for transmitted beam models									
AC/DC Sensors	Catalog Number MOSFET, Dark operate output ①	42EF-P2SCB-b	42EF-U2SCB-b	42EF-D1SCAK-b	42EF-S1SCA-b	42EF-B1SCBC-b	42EF-B1SCBE-b	42EF-G1SCA-b	42EF-R9SCB-b	42EF-R9SCBV-b	
	MOSFET, Light operate output ①	42EF-P2RCB-b	42EF-U2RCB-b	42EF-D1RCAK-b	42EF-S1RCA-b	42EF-B1RCBC-b	42EF-B1RCBE-b	42EF-G1RCA-b	42EF-R9RCB-b	42EF-R9RCBV-b	
	MOSFET, Dark operate output ②	42EF-P2SFB-b	42EF-U2SFB-b	42EF-D1SFAK-b	42EF-S1SFA-b	42EF-B1SFBC-b	42EF-B1SFBE-b	42EF-G1SFA-b	42EF-R9SFB-b	42EF-R9SFBV-b	
	MOSFET, Light operate output ②	42EF-P2RFB-b	42EF-U2RFB-b	42EF-D1RFAK-b	42EF-S1RFA-b	42EF-B1RFBC-b	42EF-B1RFBE-b	42EF-G1RFA-b	42EF-R9RFB-b	42EF-R9RFBV-b	
	Voltage/Current/Power Consumption	21.6 to 264V AC/DC @ 25mA maximum (1VA maximum) 21.6 to 132V AC/DC for 42EF-xxxFx-a models									
	Sensor Protection	Input reverse polarity, over voltage, false pulse protected, output short-circuit (SCP) to 100mA, overload									
	Output Type	Light/dark operate (N.O./N.C.) MOSFET output									
	Output Rating	264V AC/DC (132V AC/DC for 42EF-xxxFx-a models) @ 100mA maximum (SCP protected)									
	Output Leakage Current	0.4mA maximum									
Response Time	8.3ms typical, 16ms for transmitted beam models										

① Provide NPN output when wired as DC circuit.

② Provide PNP output when wired as DC circuit.

③ Contact factory for availability of 8m range receivers.

Transmitted Beam source models: 42EF-E1EZB-a (DC) and 42EF-E1QZB-b (AC/DC)

a = (-A2) 2m PVC, 300V cable, (-F4) 4-pin DC micro QD on six inch pigtail

b = (-A2) 2m PVC, 300V cable, (-G4) 4-pin AC micro QD on six inch pigtail

Typical Response Curves

Polarized Retroreflective

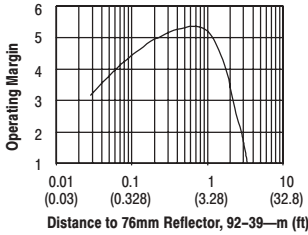

Standard Retroreflective

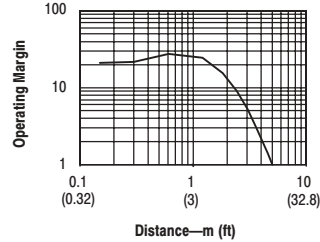

Diffuse

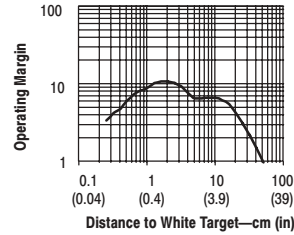

Sharp Cutoff Diffuse

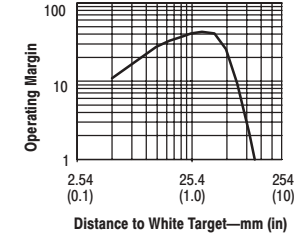

Transmitted Beam

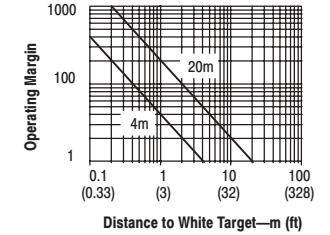

Polarized Retroreflective Beam Pattern

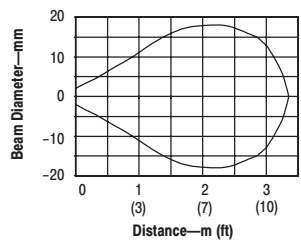

Standard Retroreflective

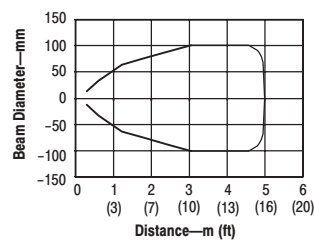

Diffuse Beam Pattern

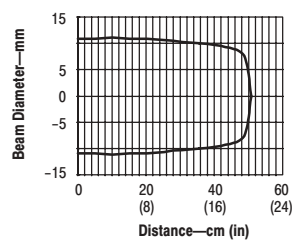

Transmitted Beam—4m Beam Pattern

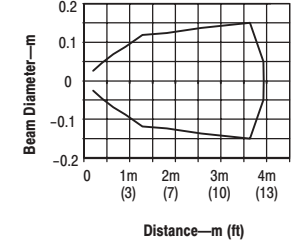

Transmitted Beam—20m Beam Pattern

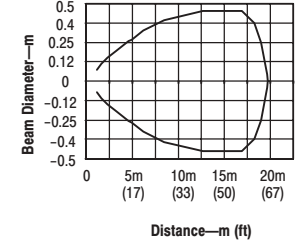

Background Suppression

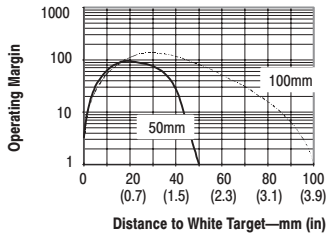

Background Suppression Beam Pattern

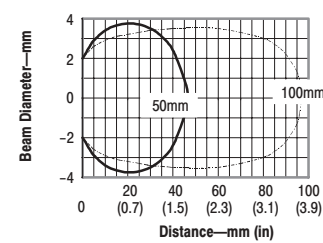

Background Suppression Sensors

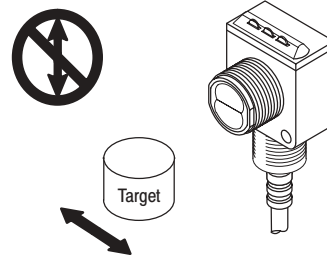

Note: Due to the detection method, targets traveling horizontal to the sensor's optics are detected. Targets traveling vertically may not be accurately detected. For reliable background suppression, a minimum separation distance of 6mm (0.24in) is recommended between the target and the backgrounds.

Glass Fiber Optic Sensors

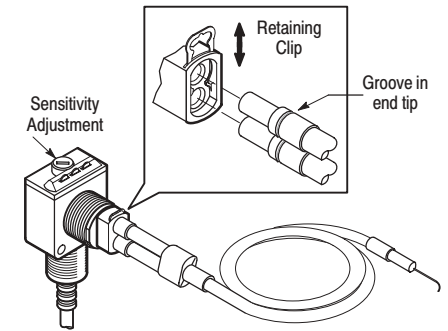

Sensor Alignment

The orange LED is an alignment aid which indicates that a margin of 2.5 has been reached. This means that the sensor is receiving at least 2.5 times the signal strength back from the target needed to trigger an output signal. In general, it is desirable to have a higher margin to help overcome any deteriorating environmental conditions, i.e. dust buildup on the sensor's lens. When aligning the sensor, the best performance can be obtained if this margin indicator is illuminated with the target in place.

When aligning diffuse mode sensors, ensure that the sensitivity be set at its maximum setting using the single-turn adjustment knob on the front panel. Pan the sensor left, right, up, and down to center the beam on the target. It may then be necessary to decrease this setting to prevent the sensor from detecting a background object. If this problem persists, the application will require the use of a background suppression, sharp cutoff diffuse, or retroreflective sensing mode.

Short-Circuit Protection

RightSight photoelectric sensors provide short-circuit protection (SCP) on the output leads. This feature is intended to protect the sensor from damage in the event that the output load is shorted to ground. If this condition does occur, the SCP will activate and the orange LED will flash until the source of the short is removed (power must be reset for AC/DC models). The SCP limits are set to 100mA over the entire voltage range for both DC and AC/DC models.

Table 1—LED Function

Label	Color	State	Status
Output	Yellow	OFF	Output de energized
		ON	Output energized
		Flashing	Output SCP active (DC models only)
Margin	Orange	OFF	Margin < 2.5
		ON	Margin > 2.5
		Flashing	Output SCP active (AC models only)
Status	Green	OFF	Sensor not powered, output active, SCP active
		ON	Sensor powered

Note: For DC models output and margin LEDs alternate flashing when SCP active.

Wiring Diagrams (continued)

10.8–30V DC Sensors

Models with Dual NPN and PNP Outputs

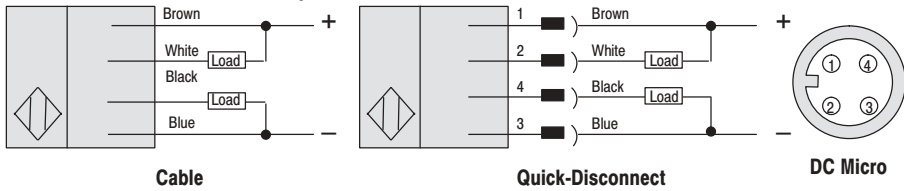

Models with NPN Outputs

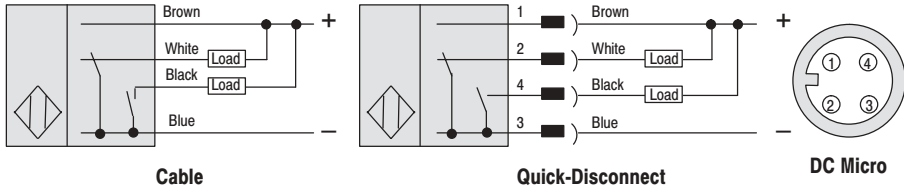

Models with PNP Outputs

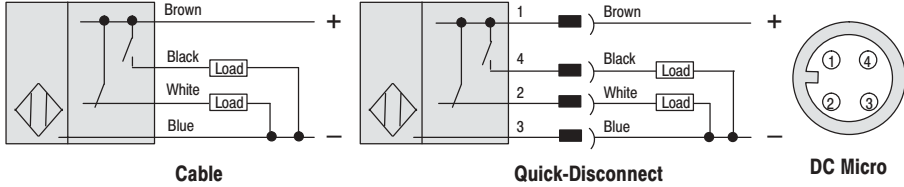

21.6–264V AC/DC Sensors

AC Wiring for 42EF-- C -- Models

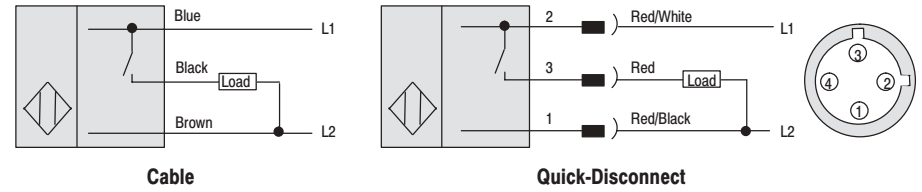

AC Wiring for 42EF-- F -- Models

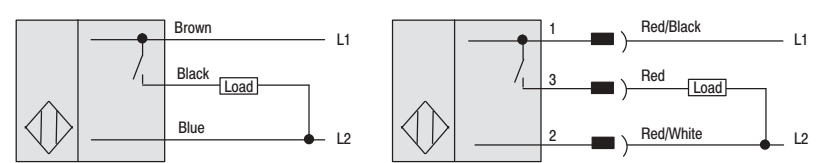

DC Wiring for 42EF-- C -- Models

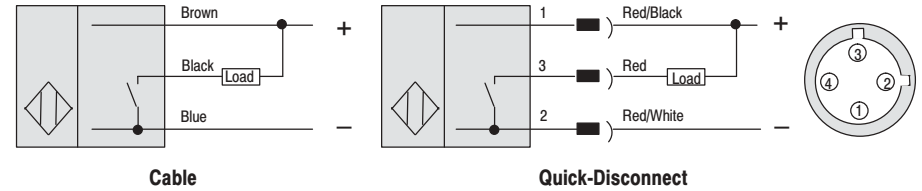

DC Wiring for 42EF-- F -- Models

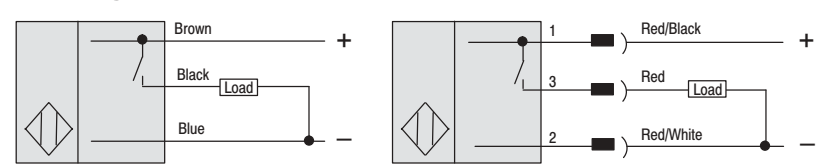

Transmitted Beam Source

AC and DC Wiring

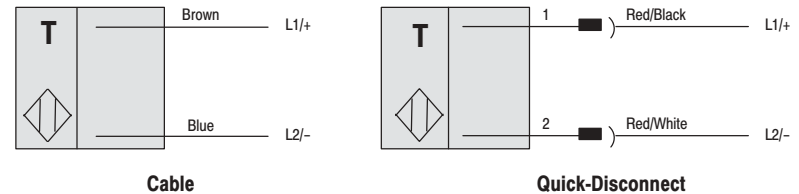

Note: All wire colors on quick-disconnect models shown refer to Allen-Bradley cordsets.

Sensor Dimensions—mm (inches)

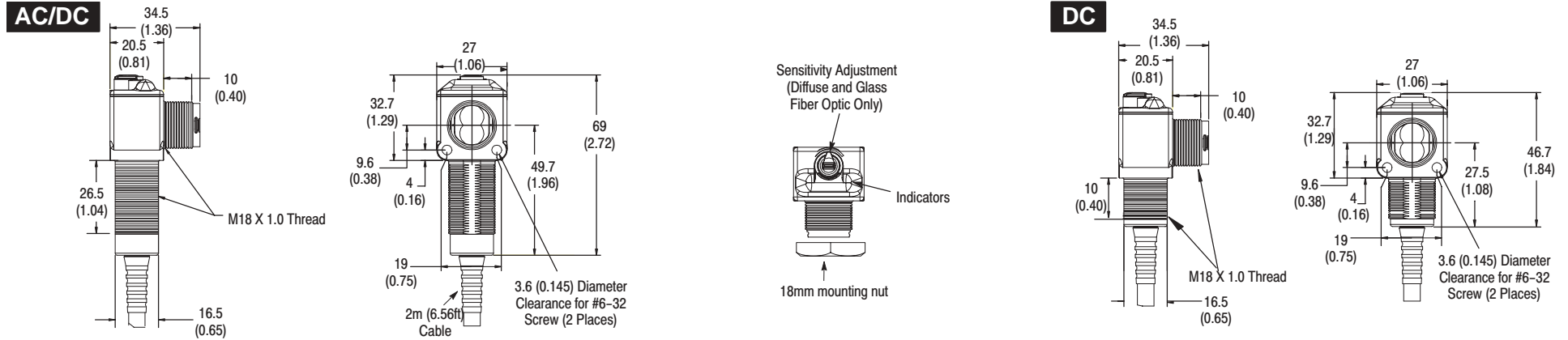

Accessories

Straight Bracket #60-2656

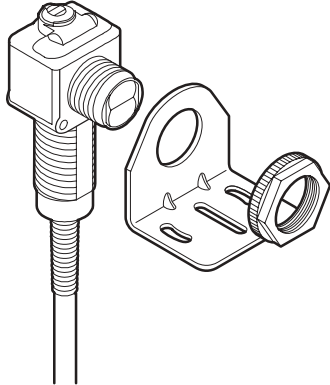

Right Angle Bracket #60-2657

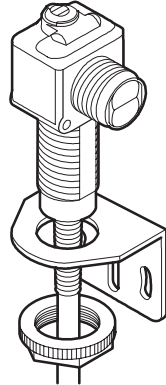

Swivel/Tilt Bracket #60-2649

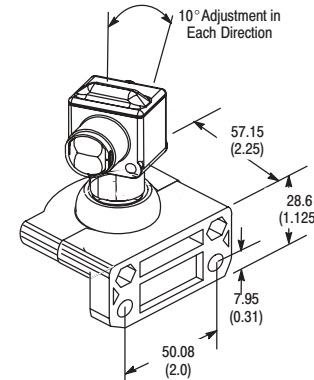

Apertures

(Transmitted Beam and Retroreflective Sensing Modes Only)

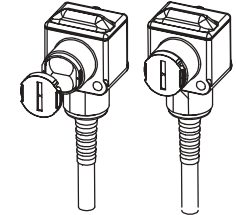

Note: 18mm nut must be installed prior to installing aperture if threads on optics snout are to be used.

1mm Qty. 20 #60-2660
2mm Qty. 20 #60-2661
4mm Qty. 20 #60-2662
Aperture Set (4 each) #60-2659

Accessories—Description	Catalog Number
Mounting Kit	60-2716
Clamp Style Bracket	871A-BP18
Flush Mount Adaptor	60-2590
Field Mount Terminal Chamber—4-pin DC Micro	871A-TS4-DM
Field Mount Terminal Chamber—3-pin AC Micro	871A-TS3-RM
Cordset—2m (6.5 ft), 4-pin DC Micro	889D-F4AC-2
Cordset—2m (6.5 ft), 4-pin AC Micro	889R-F4AEA-2
Reflector—1.25 inch diameter	92-47
Reflector—3 inch diameter	92-39
Fiber Optic Cable, Glass, Bifurcated, 5/16in threaded	43GR-TBB25SL
Fiber Optic Cable, Glass, Individual, 5/16in threaded	43FT-TBB25SL

Notes

1. Damage may occur to sensor housing if torque above 20in-lb is applied to the 18mm locknut.
2. Fiber optic sensors come with 2 18mm locknuts (75012-025-01). All other RightSight sensors come with one thick 18mm locknut (75012-097-01).
3. Optional mounting kit (60-2716) comes with two 75012-025-01, one 75012-097-01 locknut, internal tooth star washer, and screws/nuts for through-hole mounting.